



ETA-Danmark A/S
Göteborg Plads 1
DK-2150 Nordhavn
Tel. +45 72 24 59 00
Fax +45 72 24 59 04
Internet www.etadanmark.dk

Authorised and notified according
to Article 29 of the Regulation (EU)
No 305/2011 of the European
Parliament and of the Council of 9
March 2011

MEMBER OF EOTA



European Technical Assessment ETA-15/0021 of 18/06/2015

I General Part

Technical Assessment Body issuing the ETA and designated according to Article 29 of the Regulation (EU) No 305/2011: ETA-Danmark A/S

Trade name of the construction product:

Injection System Tytan EV1 / Quilosa EV1 – Winter and Standard

Product family to which the above construction product belongs:

Bonded injection type anchor for use in non-cracked concrete: sizes M8 to M16

Manufacturer:

Selena FM SA
Ul. Strzegomska 2-4
PL-Wroclaw 53-611
Poland
Tel. +487178382918
Fax +48717838291
Internet www.selena.com

Manufacturing plant:

Selena FM SA
Manufacturing Plant 2

This European Technical Assessment contains:

16 pages including 11 annexes which form an integral part of the document

This European Technical Assessment is issued in accordance with Regulation (EU) No 305/2011, on the basis of:

Guideline for European Technical Approval (ETAG) No. 001 Metal Anchors for use in concrete, Part 5 – Bonded anchors, April 2013, used as European Assessment Document (EAD).

This version replaces:

Translations of this European Technical Assessment in other languages shall fully correspond to the original issued document and should be identified as such.

Communication of this European Technical Assessment, including transmission by electronic means, shall be in full (except the confidential Annexes referred to above). However, partial reproduction may be made, with the written consent of the issuing Technical Assessment Body. Any partial reproduction has to be identified as such.

II SPECIFIC PART OF THE EUROPEAN TECHNICAL ASSESSMENT

1 Technical description of product and intended use

Technical description of the product

The Selena Tytan EV1 / Quilosa EV1 is a bonded anchor (injection type) consisting of an injection mortar cartridge equipped with a special mixing nozzle and threaded anchor rod of the sizes M8 to M16 made of galvanized carbon steel, stainless steel A4-70 or high corrosion resistant steel. See table A2 for material specification of the rods.

The threaded rod is placed into a drilled hole previously injected (using an applicator gun) with a mortar with a slow and slight twisting motion. The anchor rod is anchored by the bond between rod, mortar and concrete.

Each mortar cartridge is marked with the identifying mark of the producer and with the trade name. The mortar cartridges are available in different sizes.

The anchor in the range of M8 to M16 and the mortar cartridges corresponds to the drawings given in the Annex A1 and A2.

The characteristic material values, dimensions and tolerances of the anchors not indicated in Annexes shall correspond to the respective values laid down in the technical documentation¹ of this European Technical Assessment.

The anchors are intended to be used with embedment depth given in Annex A2, Table A1. For the installed anchor, see Figure given in Annex A2. The intended use specifications of the product are detailed in the Annex B1.

2 Specification of the intended use in accordance with the applicable EAD

The performances given in Section 3 are only valid if the anchor is used in compliance with the specifications and conditions given in Annex B1 to B9

The provisions made in this European Technical Assessment are based on an assumed intended working

life of the anchor of 50 years.

The indications given on the working life cannot be interpreted as a guarantee given by the producer or Assessment Body, but are to be regarded only as a means for choosing the right products in relation to the expected economically reasonable working life of the works.

¹ The technical documentation of this European Technical Assessment is deposited at ETA-Danmark and, as far as relevant for the tasks of the Notified bodies involved in the attestation of conformity procedure, is handed over to the notified bodies.

3 Performance of the product and references to the methods used for its assessment

Regulation, these requirements need also to be complied with, when and where they apply.

3.1 Characteristics of product

Mechanical resistance and stability (BWR 1):

The essential characteristics are detailed in the Annex from C1 to C3.

Safety in case of fire (BWR 2):

The essential characteristics are detailed in the Annex from C4.

Hygiene, health and the environment (BWR3):

The product does not contain/release dangerous substances specified in TR 034, dated March 2012.

Regarding the dangerous substances contained in this European Technical Assessment, there may be other requirements applicable to the products falling within its scope (e.g. transposed European legislation and national laws, regulations and administrative provisions). In order to meet the provisions of the Construction Products Regulation, these requirements need also to be complied with, when and where they apply.

Safety in use (BWR4):

For basic requirement Safety in use the same criteria are valid for Basic Requirement Mechanical resistance and stability (BWR1).

Sustainable use of natural resources (BWR7)

No performance determined

Other Basic Requirements are not relevant.

3.2 Methods of assessment

The assessment of fitness of the anchor for the intended use in relation to the requirements for mechanical resistance and stability and safety in use in the sense of the Basic Requirements 1 and 4 has been made in accordance with the « Guideline for European Technical Assessment of Metal Anchors for use in Concrete », Part 1 « Anchors in general » and Part 5 « Bonded anchors », on the basis of Option 7.

In addition to the specific clauses relating to dangerous substances contained in this European technical Assessment, there may be other requirements applicable to the products falling within its scope (e.g. transposed European legislation and national laws, regulations and administrative provisions). In order to meet the provisions of the Construction Products

4 Assessment and verification of constancy of performance (AVCP)

4.1 AVCP system

According to the decision 96/582/EC of the European Commission, the system(s) of assessment and verification of constancy of performance (see Annex V to Regulation (EU) No 305/2011) is 1.

5 Technical details necessary for the implementation of the AVCP system, as foreseen in the applicable EAD

Technical details necessary for the implementation of the AVCP system are laid down in the control plan deposited at ETA-Danmark

Issued in Copenhagen on 2015-06-18 by

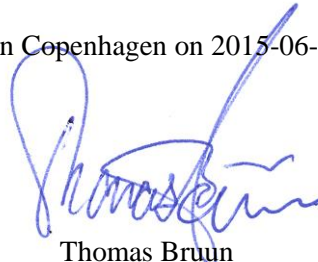

Thomas Bruun
Managing Director, ETA-Danmark

Injection Mortar : Selena TYTAN EV1 / QUILOSA EV1 – Winter & Standard Resin System

Foil Bag Cartridge 165ml - 410ml



Coaxial Cartridge
280ml, 380ml - 410ml

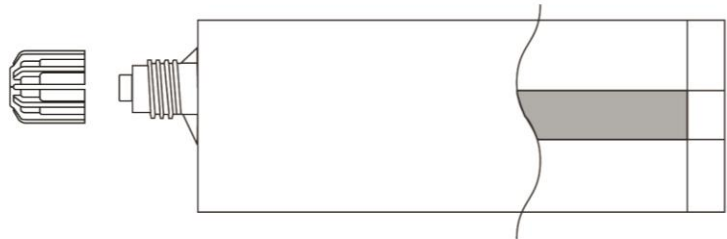

Side by Side Cartridge
235ml - 825ml

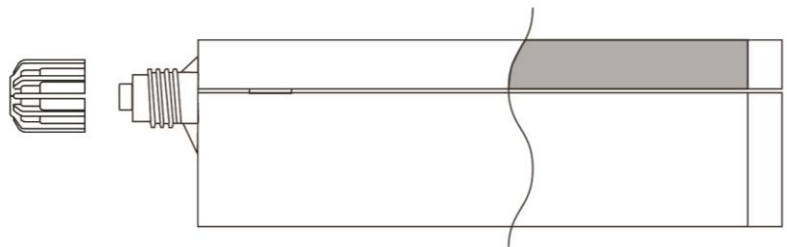

Marking:

Selena TYTAN EV1 / QUILOSA EV1

Batch code, either expiry date or manufacturing date with shelf life

Mixer with hanger

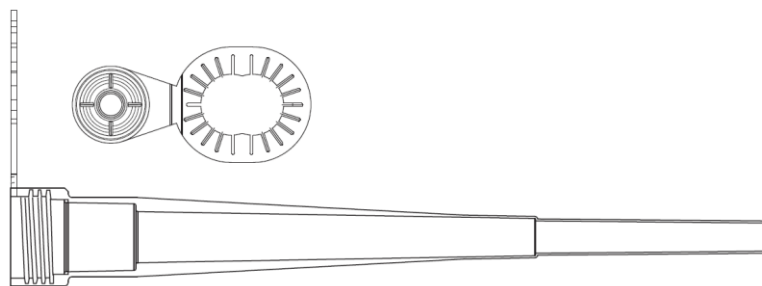

Mixer

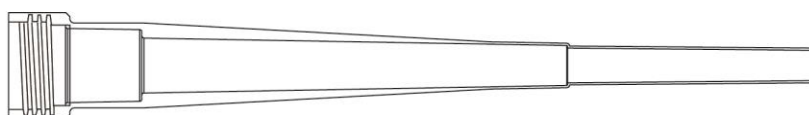

SYSTEM SELENA TYTAN EV1 / QUILOSA EV1

Product and intended use

Annex A1
of European
Technical Assessment
ETA-15/0021

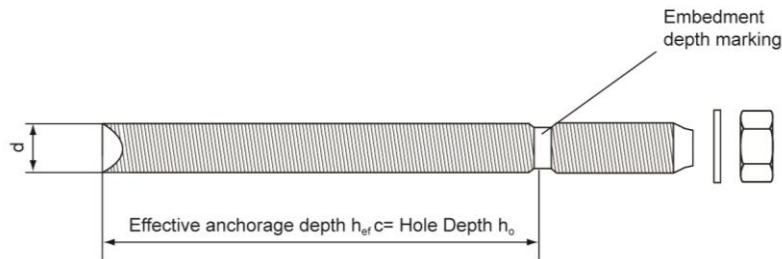
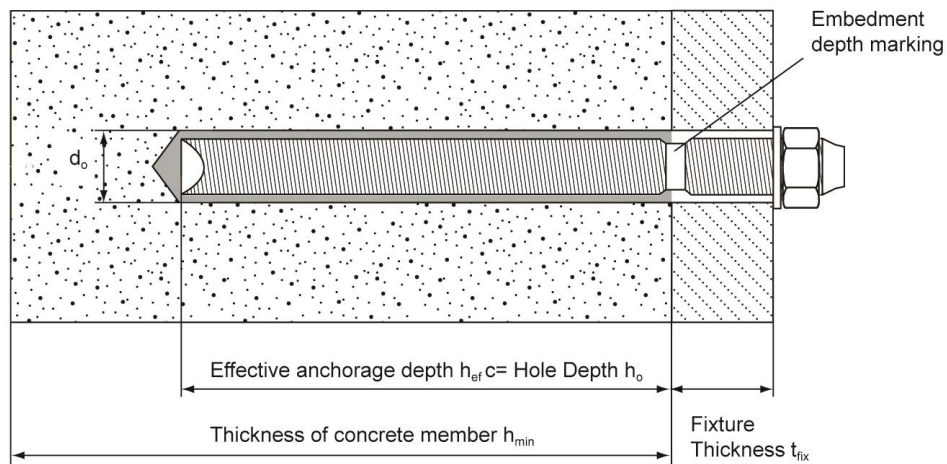

Table A1: Threaded rod dimensions

Anchor size		M8	M10	M12	M16
Diameter of anchor rod	d [mm] =	8	10	12	16
Range of anchor depth h_{ef} and bore hole depth h_o	min [mm] =	60	60	70	80
	max [mm] =	160	200	240	320
Nominal anchorage depth	h_{ef} [mm] =	80	90	110	125
Nominal diameter of drill bit	d_o [mm] =	10	12	14	18
Diameter of clearance hole in the fixture	d_f [mm] ≤	9	12	14	18
Diameter of steel brush	d_b [mm] ≤	12	13,3	14,9	19,35
Installation torque moment	T_{inst} [Nm] =	8	10	15	25
Minimum thickness of concrete member	h_{min} [mm]	$h_{ef} + 30 \text{ mm} \geq 100 \text{ mm}$			$h_{ef} + 2d_o$
Minimum spacing	S_{min} [mm] =	0,5 h_{ef}			
Minimum edge distance	C_{min} [mm] =	0,5 h_{ef}			

SYSTEM SELENA TYTAN EV1 / QUILOSA EV1

Threaded rod types and dimensions

Annex A2
of European
Technical Assessment
ETA-15/0021

Table A2: Threaded rod materials

Designation	Material
Threaded rods made of zinc coated steel	
Threaded rod M8 – M16	Strength class 5.8, 8.8, 10.9 EN ISO 898-1 Steel galvanized $\geq 5\mu\text{m}$ EN ISO 4042 Hot dipped galvanized $\geq 45\mu\text{m}$ EN ISO 10684
Washer ISO 7089	Steel galvanized EN ISO 4042; hot dipped galvanized EN ISO 10684
Nut EN ISO 4032	Strength class 8 EN ISO 898-2 Steel galvanized $\geq 5\mu\text{m}$ EN ISO 4042 Hot dipped galvanized $\geq 45\mu\text{m}$ EN ISO 10684
Threaded rods made of stainless steel	
Threaded rod M8 – M16	Strength class 70 EN ISO 3506-1; Stainless steel 1.4401; 1.4404; 1.4578; 1.4571; 1.4439; 1.4362 en 10088
Washer ISO 7089	Stainless steel 1.4401; 1.4404; 1.4578; 1.4571; 1.4439; 1.4362 en 10088
Nut EN ISO 4032	Strength class 70 EN ISO 3506-1; Stainless steel 1.4401; 1.4404; 1.4578; 1.4571; 1.4439; 1.4362 en 10088
Threaded rods made of high corrosion resistant steel	
Threaded rod M8 – M16	$R_m = 800 \text{ N/mm}^2$; $R_{p0,2}=640 \text{ N/mm}^2$ High corrosion resistant steel 1.4529, 1.4565 EN 10088
Washer ISO 7089	High corrosion resistant steel 1.4529, 1.4565 EN 10088
Nut EN ISO 4032	Strength class 70 EN ISO 3506-2; High corrosion resistant steel 1.4529, 1.4565 EN 10088

SYSTEM SELENA TYTAN EV1 / QUILOSA EV1

Materials

Annex A3
of European
Technical Assessment
ETA-15/0021

Use:

The anchors are intended to be used for anchorages for which requirements for mechanical resistance and stability and safety in use in the sense of the Basic Requirements 1 and 4 of Regulation 305/2011 (EU) shall be fulfilled and failure of anchorages made with these products would compromise the stability of the works, cause risk to human life and/or lead to considerable economic consequences.

Anchors subject to:

- Static and quasi-static loads: sizes from M8 to M16.

Base materials:

- Reinforced or unreinforced normal weight concrete of strength class C20/25 at minimum to C50/60 at maximum according to EN 206-1.
- Non cracked concrete: sizes from M8 to M16

Temperature range:

The anchors may be used in the following temperature range:

- (a) Winter version: max short term temperature + 40 °C and max long term temperature + 24 °C;
- (b) Standard version: max short term temperature + 80 °C and max long term temperature + 50 °C.

Use conditions (Environmental conditions):

Elements made of galvanized steel and stainless steel may be used in structures subject to the following conditions:

- Internal dry conditions
- Dry internal conditions, external atmospheric exposure (including industrial and marine environment) or exposure in permanently damp internal conditions if no particular aggressive conditions exist.
- dry internal conditions, external atmospheric exposure, in permanently damp internal conditions or in other particular aggressive conditions - e.g. permanent, alternating immersion in seawater, splash zone of seawater, chloride atmosphere of indoor swimming pools or atmosphere with chemical pollution (e.g. in desulphurization plants or road tunnels where de-icing materials are used).

Installation:

The anchors may be installed in:



- Dry or wet concrete (use category 1): sizes from M8 to M16.
- Flooded holes with the exception of seawater (use category 2): sizes from M8 to M16.
- All the diameters may be used overhead: sizes from M8 to M16.
- The anchor is suitable for hammer drilled holes: sizes from M8 to M16.

Proposed design methods:

- Static and quasi-static load: EOTA Technical Report TR029 (September 2010) or CEN/TS 1992-4:2009.

SYSTEM SELENA TYTAN EV1 / QUILOSA EV1	Annex B1 of European Technical Assessment ETA-15/0021
Intended use - Specification	

Table B1: Installation data

Threaded rod And rebar	Size	Nominal drill bit diameter d _o (mm)	Steel Brush	Cleaning methods	
				Manual cleaning (MAC)	Compressed air cleaning (CAC)
				Manual cleaning (MAC)	Compressed air cleaning (CAC)
	M8	10	12mm	Yes ... h _{ef} ≤ 80 mm	Yes
	M10	12	14mm	Yes ... h _{ef} ≤ 100mm	
	M12	14	16mm	Yes ... h _{ef} ≤ 120mm	
	M16	18	20mm	Yes ... h _{ef} ≤ 160mm	

Manual Cleaning (MAC):

Selena hand pump recommended for Blowing out bore holes with diameters d_o ≤ 24 mm and bore holes depth h_o ≤ 10d



Compressed air cleaning (CAC):

Recommended air nozzle with an Orifice opening of minimum 3,5mm in diameter.



Table B2: Minimum curing time

Minimum base material temperature C°	Gel time (working time) In dry/wet concrete	Cure time
-5°C ≤ T _{base material} < 0°C	40 min	180 min
0°C ≤ T _{base material} < 10°C	20 min	90 min
10°C ≤ T _{base material} < 20°C	9 min	60 min
20°C ≤ T _{base material} < 30°C	5 min	30 min
30°C ≤ T _{base material} ≤ 40°C	3 min	20 min

The temperature of the bond material must be ≥ 20°C

SYSTEM SELENA TYTAN EV1 / QUILOSA EV1	Annex B2 of European Technical Assessment ETA-15/0021
Intended use - data	

Table B3 - parameters: drilling, hole cleaning and installation		
Bore hole drilling		
		Drill hole in the substrate to the required embedment depth using the appropriately sized carbide drill bit.
Bore hole cleaning Just before setting an anchor, the bore hole must be free of dust and debris.		
a) Manual air cleaning (MAC) for all bore hole diameters $d_o \leq 24\text{mm}$ and bore hole depth $h_o \leq 10d$		
	X 4	The Selena manual pump shall be used for blowing out bore holes up to diameters $d_o \leq 24\text{mm}$ and embedment depths up to $h_{ef} \leq 10d$. Blow out at least 4 times from the back of the bore hole, using an extension if needed.
	X 4	Brush 4 times with the specified brush size (see Table B1) by inserting the Selena steel brush to the back of the hole (if needed with an extension) in a twisting motion and removing it.
	X 4	Blow out again with manual pump at least 4 times.
b) Compressed air cleaning (CAC) for all bore hole diameters d_o and all bore hole depths		
	X 2	Blow 2 times from the back of the hole (if needed with a nozzle extension) over the whole length with oil-free compressed air (min. 6 bar at 6 m ³ /h).
	X 2	Brush 2 times with the specified brush size (see Table B1) by inserting the Selena steel brush to the back of the hole (if needed with an extension) in a twisting motion and removing it.
	X 2	Blow out again with compressed air at least 2 times.
SYSTEM SELENA TYTAN EV1 / QUILOSA EV1		Annex B3 of European Technical Assessment ETA-15/0021
Procedure (1)		

Table B4 - parameters: drilling, hole cleaning and installation



Remove the threaded cap from the cartridge.

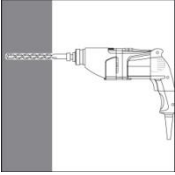
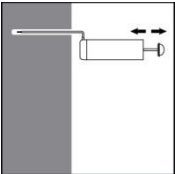
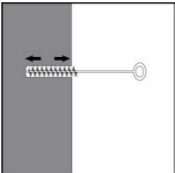
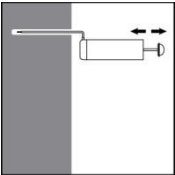
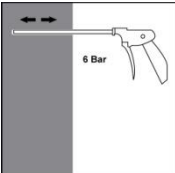
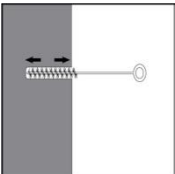
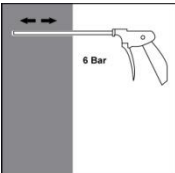
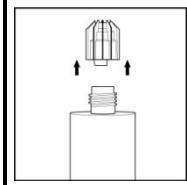
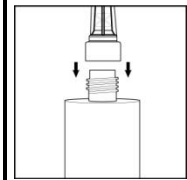

Tightly attach the mixing nozzle. Do not modify the mixer in any way. Make sure the mixing element is inside the mixer. Use only the supplied mixer.

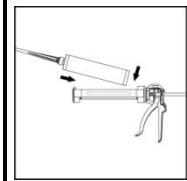

Insert the cartridge into the Selena dispenser gun.

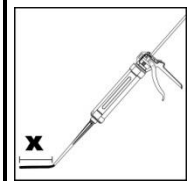

Discard the initial trigger pulls of adhesive. Depending on the size of the cartridge, an initial amount of adhesive mix must be discarded.

Discard quantities are - 5cm for between 150ml, 300ml & 400ml Foil Pack
- 10cm for all other cartridges

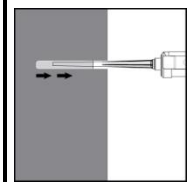

Inject the adhesive starting at the back of the hole, slowly withdrawing the mixer with each trigger pull.
Fill holes approximately 2/3 full, to ensure that the annular gap between the anchor and the concrete is completely filled with adhesive along the embedment depth.

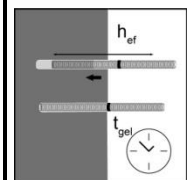

Before use, verify that the threaded rod is dry and free of contaminants.

Install the threaded rod to the required embedment depth during the open gel time t_{gel} has elapsed. The working time t_{gel} is given in Table B2.

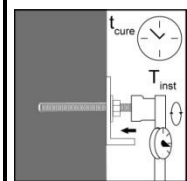

The anchor can be loaded after the required curing time t_{cure} (see Table B2). The applied torque shall not exceed the values T_{max} given in Table A1.

SYSTEM SELENA TYTAN EV1 / QUILOSA EV1

Procedure (2)

Annex B4
of European
Technical Assessment
ETA-15/0021

Table C1: Design method A, characteristic tension load values

SELENA TYTAN EV1 / QUILOSA EV1 with threaded rods			M8	M10	M12	M16
Steel failure						
Characteristic resistance, class 5.8	$N_{Rk,s}$	[kN]	18	29	42	79
Characteristic resistance, class 8.8	$N_{Rk,s}$	[kN]	29	46	67	126
Partial safety factor	$\gamma_{Ms,N}^{1)}$	[-]	1,5			
Characteristic resistance, class 10.9	$N_{Rk,s}$	[kN]	36	58	84	157
Partial safety factor	$\gamma_{Ms,N}^{1)}$	[-]	1,4			
Characteristic resistance, A4-70	$N_{Rk,s}$	[kN]	26	41	59	110
Partial safety factor	$\gamma_{Ms,N}^{1)}$	[-]	1,87			
Characteristic resistance, HCR	$N_{Rk,s}$	[kN]	29	46	67	126
Partial safety factor	$\gamma_{Ms,N}^{1)}$	[-]	1,5			
Combined Pull-out and Concrete cone failure ²⁾						
Diameter of threaded rod	d	[mm]	8	10	12	16
Characteristic bond resistance in non-cracked concrete C20/25 – dry or wet concrete						
Temperature range a ³⁾ : 40°C/24°C	$\tau_{Rk,ucr}$	[N/mm ²]	6,0	5,5	5,0	4,0
Temperature range b ³⁾ : 80°C/50°C	$\tau_{Rk,ucr}$	[N/mm ²]	4,5	4,0	3,5	3,0
Partial safety factor – dry or wet concrete	$\gamma_{Mp}=\gamma_{Mc}^{1)}$	[-]	2,1 ⁵⁾	1,8 ⁶⁾		
Characteristic bond resistance in non-cracked concrete C20/25 – flooded holes						
Temperature range a ³⁾ : 40°C/24°C	$\tau_{Rk,ucr}$	[N/mm ²]	5,0	4,0	4,0	3,5
Temperature range lb ³⁾ : 80°C/50°C	$\tau_{Rk,ucr}$	[N/mm ²]	3,5	3,0	3,0	3,0
Partial safety factor – flooded holes	$\gamma_{Mp}=\gamma_{Mc}^{1)}$	[-]	2,1 ⁵⁾			
Increasing factor for $\tau_{Rk,ucr}$ in non-cracked concrete	ψ_c	C30/37	1,08			
		C40/50	1,15			
		C50/60	1,19			
Splitting failure²⁾						
Edge distance $c_{cr,sp}$ [mm] for	$h / h_{ef}^{4)} \geq 2,0$		1,0 h_{ef}			
	$2,0 > h / h_{ef}^{4)} > 1,3$		5,28 h_{ef} - 2,14 h			
	$h / h_{ef}^{4)} \leq 1,3$		2,5 h_{ef}			
Spacing	$s_{cr,sp}$	[mm]	2 $c_{cr,sp}$			
Partial safety factor – dry or wet concrete	$\gamma_{Msp}=\gamma_{Mc}^{1)}$	[-]	2,1 ⁵⁾	1,8 ⁶⁾		
Partial safety factor – flooded holes	$\gamma_{Msp}=\gamma_{Mc}^{1)}$	[-]	2,1 ⁵⁾			

¹⁾ In absence of national regulations²⁾ Calculation of concrete and splitting, see annex B1³⁾ Explanations, see annex B1⁴⁾ h concrete member thickness, h_{ef} effective anchorage depth⁵⁾ The partial safety factor $\gamma_{inst}=1,4$ included⁶⁾ The partial safety factor $\gamma_{inst}=1,2$ included**SYSTEM SELENA TYTAN EV1 / QUILOSA EV1**

Performance for static and quasi-static loads: Resistances

Annex C1
of European
Technical Assessment
ETA-15/0021

Table C2: Displacements under tension load

SELENA TYTAN EV1 / QUILOSA EV1 with threaded rods			M8	M10	M12	M16
Temperature range a⁷⁾: 40°C / 24°C						
Admissible service load	F	[kN]	9,0	10,4	13,2	16,1
Displacement	δ_{N0}	[mm]	0,22	0,21	0,19	0,25
Displacement	$\delta_{N\infty}$	[mm]	-	-	0,29	-
Temperature range b⁷⁾: 80°C / 50°C						
Admissible service load	F	[kN]	6,8	7,5	9,2	12,1
Displacement	δ_{N0}	[mm]	0,35	0,33	0,30	0,40
Displacement	$\delta_{N\infty}$	[mm]	-	-	0,38	-

⁷⁾ Explanation see annex B1

SYSTEM SELENA TYTAN EV1 / QUILOSA EV1

Performance for static, quasi-static: Displacements

Annex C2
of European
Technical Assessment
ETA-15/0021

Table C3: Design method A, Characteristic shear load values

SELENA TYTAN EV1 / QUILOSA EV1 with threaded rods		M8	M10	M12	M16
Steel failure without lever arm					
Characteristic resistance, class 5.8	$V_{Rk,s}$ [kN]	9	15	21	39
Characteristic resistance, class 8.8	$V_{Rk,s}$ [kN]	15	23	34	63
Characteristic resistance, class 10.9	$V_{Rk,s}$ [kN]	18	29	42	79
Characteristic resistance, A4-70	$V_{Rk,s}$ [kN]	13	20	30	55
Characteristic resistance, HCR	$V_{Rk,s}$ [kN]	15	23	34	62,8
Steel failure with lever arm					
Characteristic resistance, class 5.8	$M^0_{Rk,s}$ [Nm]	19	37	66	167
Characteristic resistance, class 8.8	$M^0_{Rk,s}$ [Nm]	30	60	105	266
Characteristic resistance, class 10.9	$M^0_{Rk,s}$ [Nm]	38	75	131	333
Characteristic resistance, A4-70	$M^0_{Rk,s}$ [Nm]	26	53	92	233
Characteristic resistance, HCR	$M^0_{Rk,s}$ [Nm]	30	60	105	266
Partial safety factor steel failure					
grade 5.8 or 8.8	$\gamma_{Ms,V^1)}$ [-]	1,25			
grade 10.9	$\gamma_{Ms,V^1)}$ [-]	1,50			
A4-70	$\gamma_{Ms,V^1)}$ [-]	1,56			
HCR	$\gamma_{Ms,V^1)}$ [-]	1,25			
Concrete edge failure					
Factor in equation (27) of CEN/TS 1992-4-5, 6.3.3	k_3 [-]	2,0			
Partial safety factor	$\gamma_{Mc}^{1)}$ [-]	2,1 ⁵⁾	1,8 ⁶⁾		
Concrete edge failure					
Partial safety factor	$\gamma_{Mc}^{1)}$ [-]	2,1 ⁵⁾	1,8 ⁶⁾		

¹⁾ In absence of national regulations

⁵⁾ The partial safety factor $\gamma_{inst}=1,4$ included

⁶⁾ The partial safety factor $\gamma_{inst}=1,2$ included.

Table C4: Displacements under shear load

SELENA TYTAN EV1 / QUILOSA EV1 with threaded rods		M8	M10	M12	M16
Displacement ⁸⁾	δ_{V0} [mm/kN]	0,06	0,06	0,05	0,04
Displacement ⁸⁾	$\delta_{V\infty}$ [mm/kN]	0,09	0,08	0,08	0,06

⁸⁾ Calculation of displacement under service load: V_{sd} design value of shear load

Displacement under short term loading = $\delta_{V0} \cdot V_{sd}/1,4$

Displacement under short term loading = $\delta_{V\infty} \cdot V_{sd}/1,4$

SYSTEM SELENA TYTAN EV1 / QUILOSA EV1

Performance for static, quasi-static and seismic loads: Displacements

Annex C3
of European
Technical Assessment
ETA-15/0021

Table C5: Resistance to fire

HARMONIZED TECHNICAL SPECIFICATION: ETAG 001 PART 1 PARAGRAPH 5.2.2 AND TECHNICAL REPORT TR020	
ESSENTIAL CHARACTERISTICS	PERFORMANCE
Resistance to fire	NPD

Table C6: Reaction to fire

HARMONIZED TECHNICAL SPECIFICATION: ETAG 001 PART 1 PARAGRAPH 5.2.1	
ESSENTIAL CHARACTERISTICS	PERFORMANCE
Reaction to fire	In the final application, the thickness of the mortar layer is about 1 to 2 mm and most of the mortar is material classified class A1 according to EC Decision 96/603/EC. Therefore, it may be assumed that the bonding material (synthetic mortar or a mixture of synthetic mortar and cementitious mortar) in connection with the metal anchor in the end use application do not contribute to fire growth or to the fully developed fire and they have no influence to the smoke hazard.

SYSTEM SELENA TYTAN EV1 / QUILOSA EV1

Performance for exposure to fire

Annex C4
of European
Technical Assessment
ETA-15/0021